

CW-WZ-0109

4G Magentic Antenna

Key Features

Frequency: 698-960/1710-2700MHz

SMA Male Connector

External Magnetic Base

Dimensions 110*30 mm



1. Antenna Electrical Characteristics

Band (MHz)	
Frequency (MHz)	698-960MHZ/1710-2700MHZ
VSWR	2/2.5
Efficiency (%)	58.24%/59.18%
Peak Gain (dBi)	2.72/2.86
Impedance (Ohm)	50
Polarisation	Vertical
Max. Input Power (W)	10
Connector Type	SMA Male

2. Material and environmental characteristics

Inner structure	Copper tube
Material of Plastic	ABS/TPE
Cable Type	RG174
Connector Type	SMA Male
Dimensions (mm)	110*30MM
Antenna color	Black
Operation Temperature	-40 to +80
Storage Temperature	-40 to +80
Antenna Storage life(year)	10
Substance Compliance	ROHS

REV	Date	Description
X1	2023/02/16	New Issue

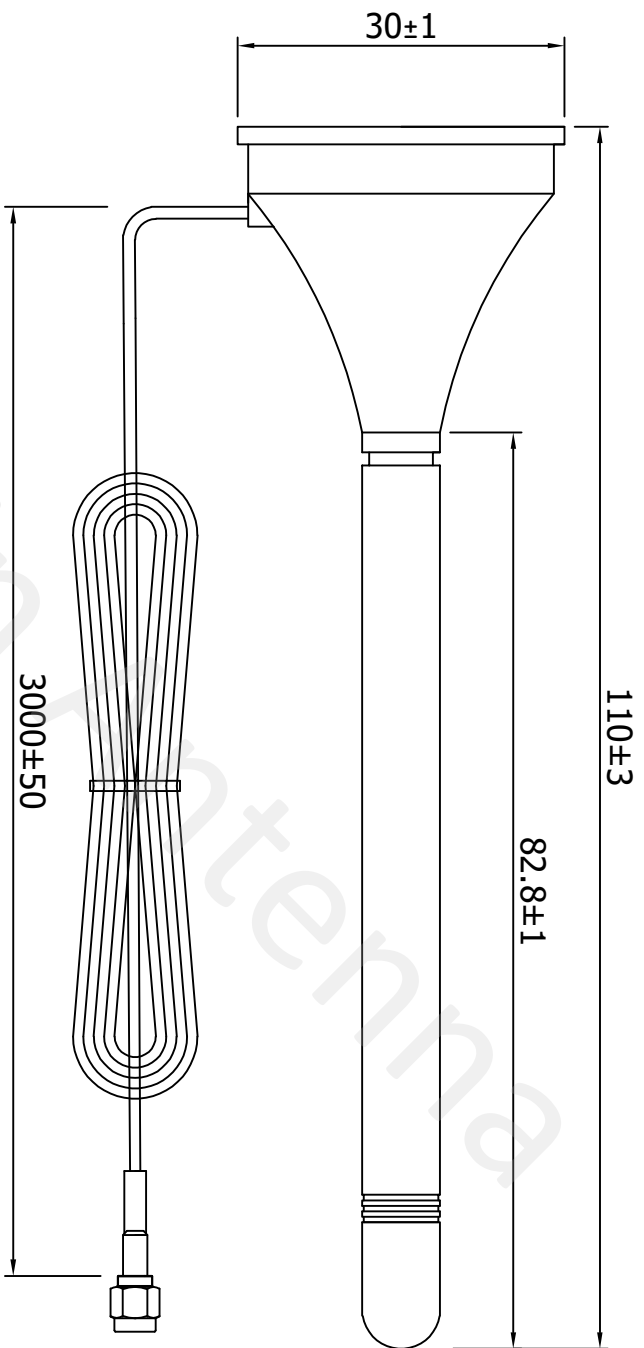

Specification(Free Test):
 Frequency Range:698-960MHZ/1710-2700MHZ
 Impedance: 50Ω
 V.S.W.R:≤2/2.5
 100% Continuity,short and open circuit test
 Materials,parts and process must by environmentally (ROHS)

8	Tube	3.5*15MM Heat shrinkable tube	1		
7	Signal tube	Copper	1		
6	Radome	Black TPE	1		
5	Bottom cover	Black ABS	1		
4	Sticker	29*1mm	1		
3	Magnet	Magnet	1		
2	Cable	RG174 Cable	1		
1	Connector	SMA Male	1		
NO	Name	Description	QTY	Remark	
XX	±5.0	Approved			
X	±3.0	Checked			
.X	±1.0				
.XX	±0.2	Drawing			
.XXX	±0.1				
⊕					

Customer	Part NO.	Part name	CW P/NO.	REV	Unit	File	Sheet
		External antenna	CW-WZ-0109	X1	m/m		1/1



4. Antenna test parameters

Antenna Measurement Conditions:

Mounted on Ground Plane of 280 x 80 mm

Measured in Certified 3D Anechoic Chamber

The network analyzer is Agilent 5071c

The comprehensive tester is Agilent cmv500

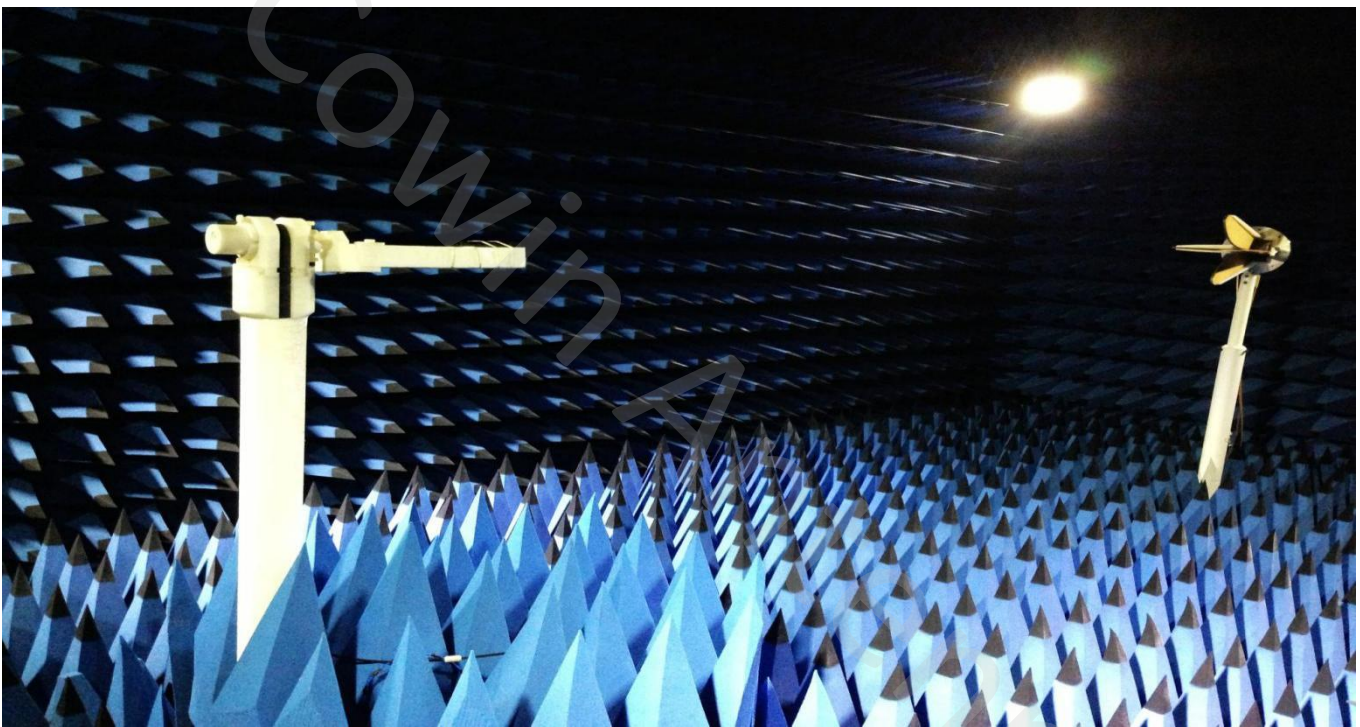

4.1 VSWR

Trc1 S11 SWR 1 U / Ref 1 U Cal



1

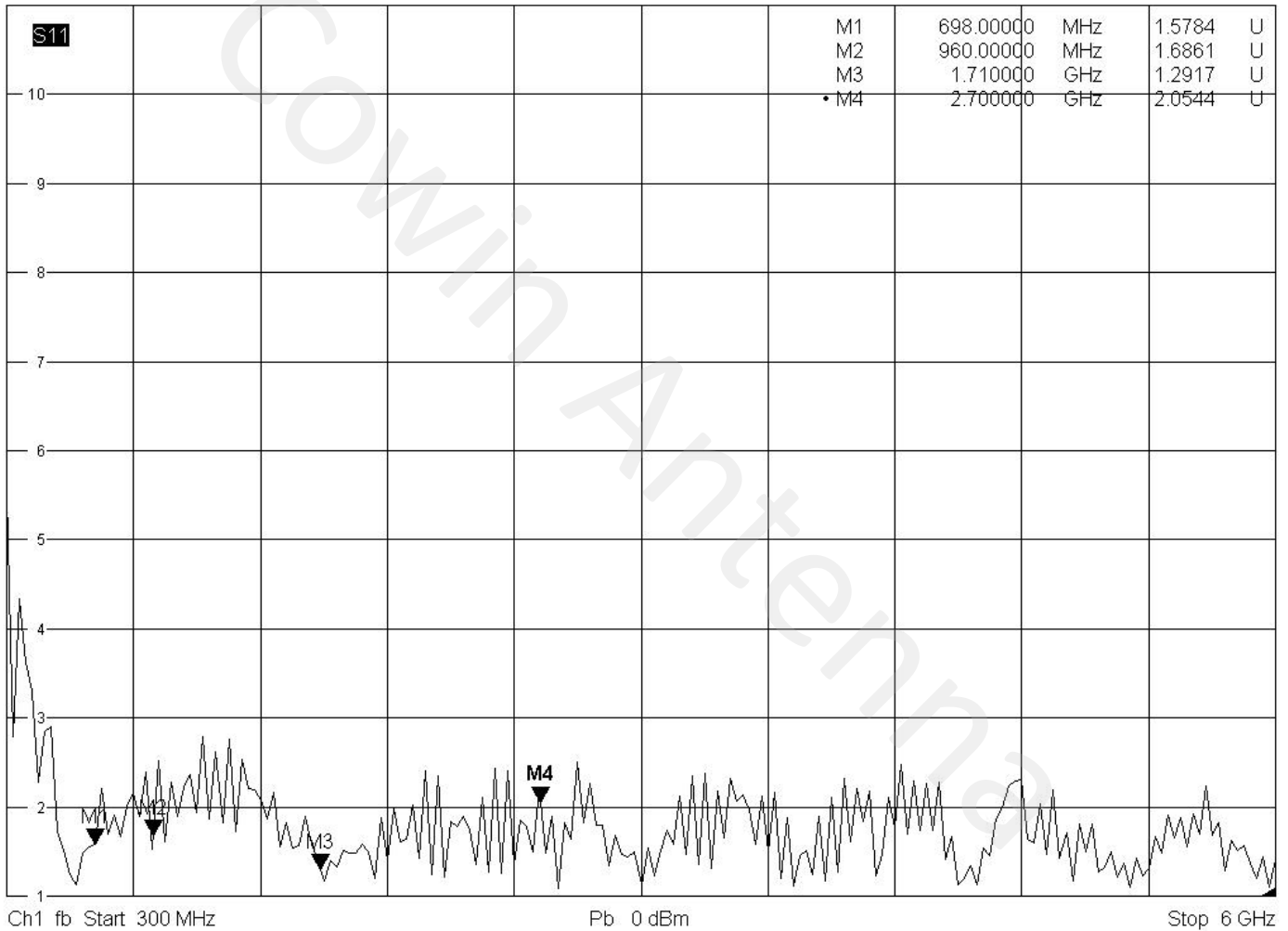

2/16/2023, 2:52 AM

4.2 Efficiency

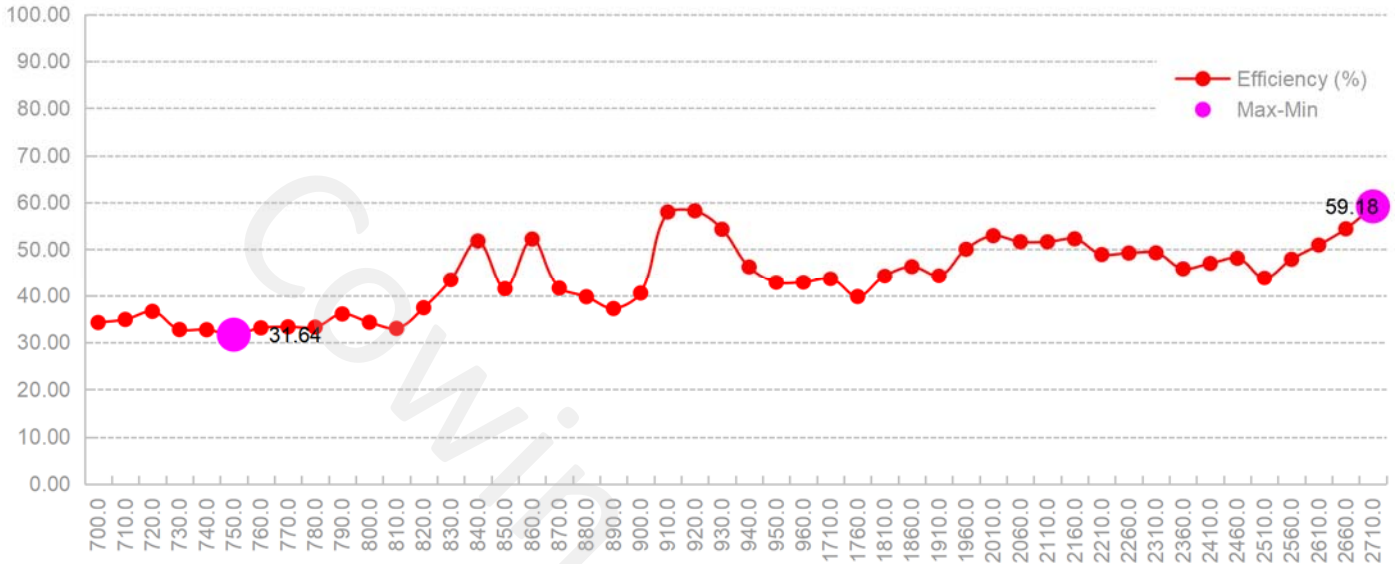

4.3 Peak gain

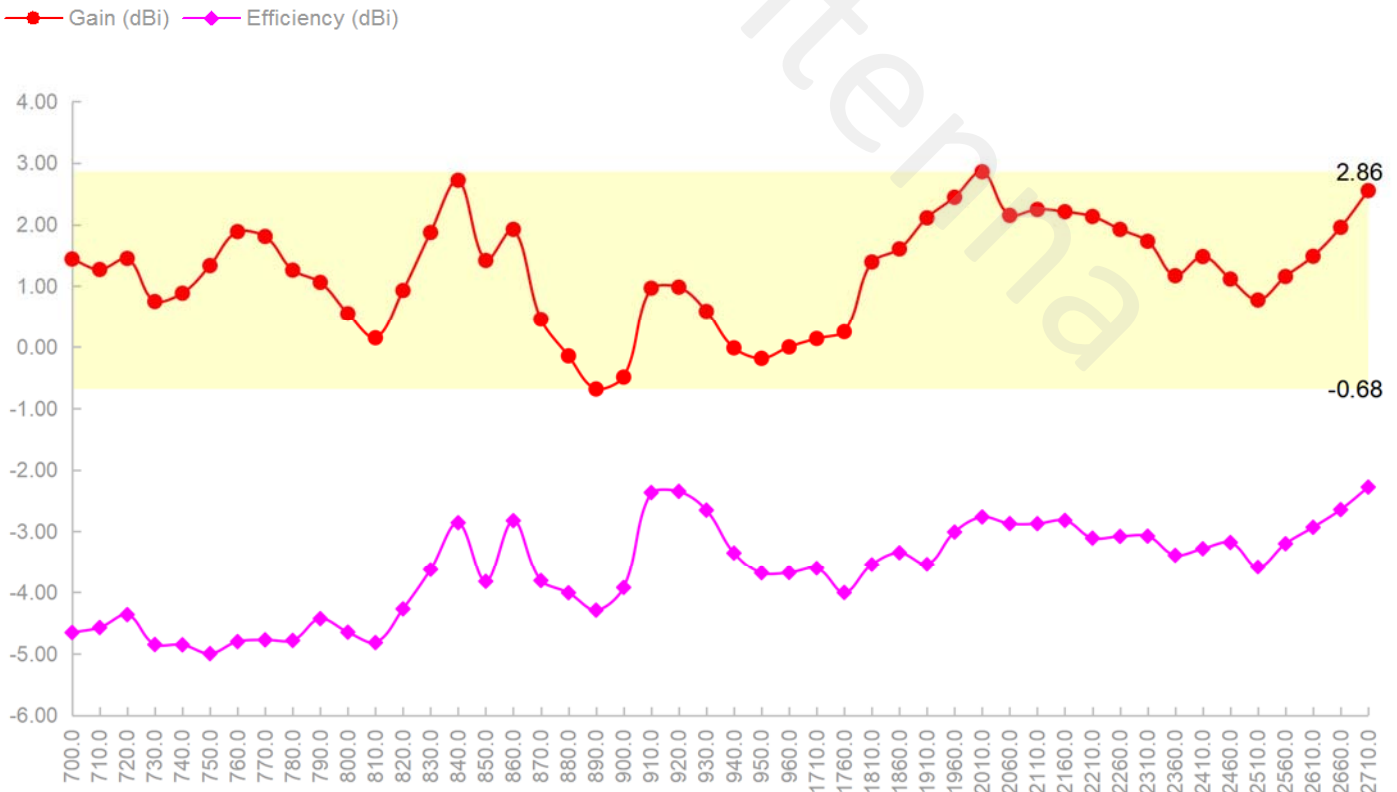

4.4 3D&2D Radiation Patterns

700.0MHz H+V, Eff: 34.2%

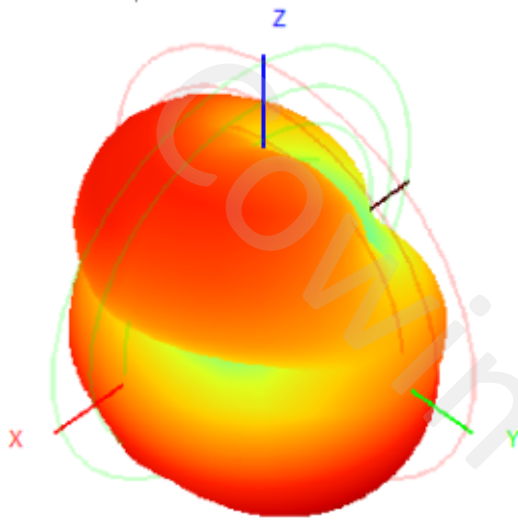

Back View

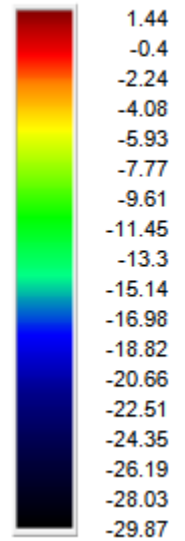
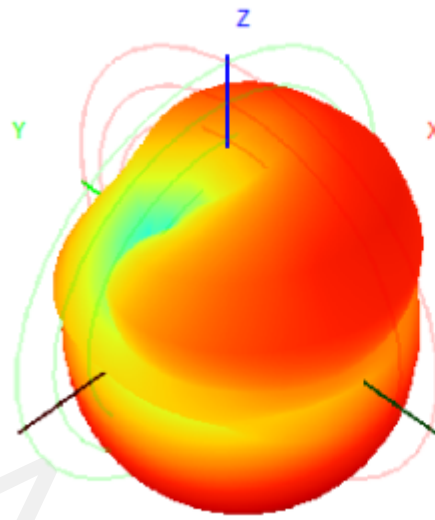

700.0MHz Total(E1-XZ), Max=-0.78dBi

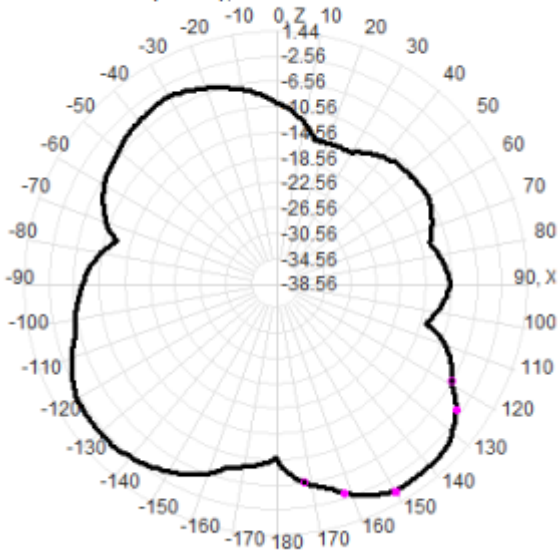

700.0MHz Total(E2-YZ), Max= 1.44dBi

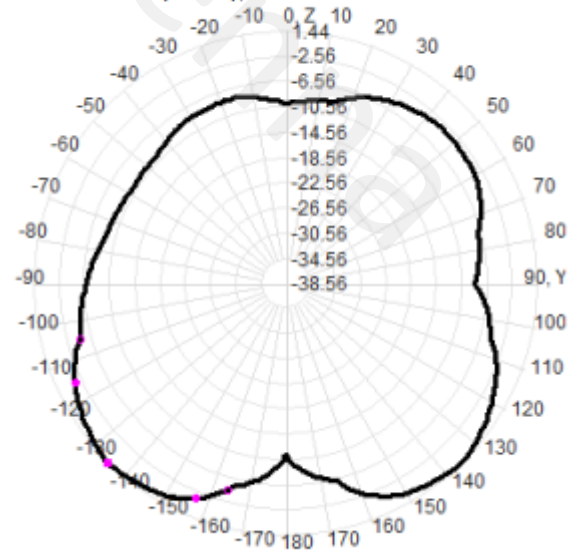

850.0MHz H+V, Eff: 41.5%

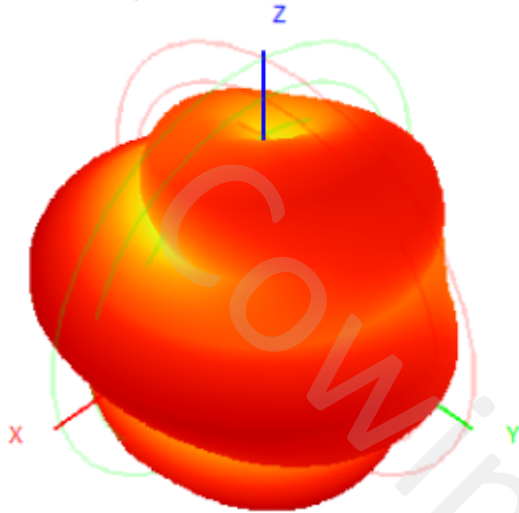

Back View

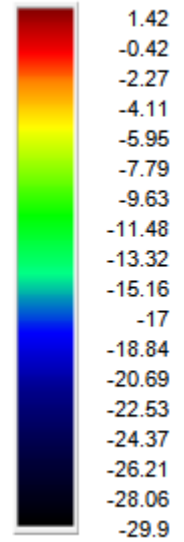
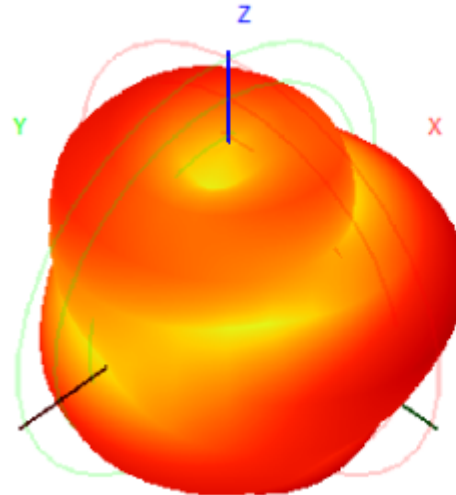

850.0MHz Total(E1-XZ), Max= -0.49dBi

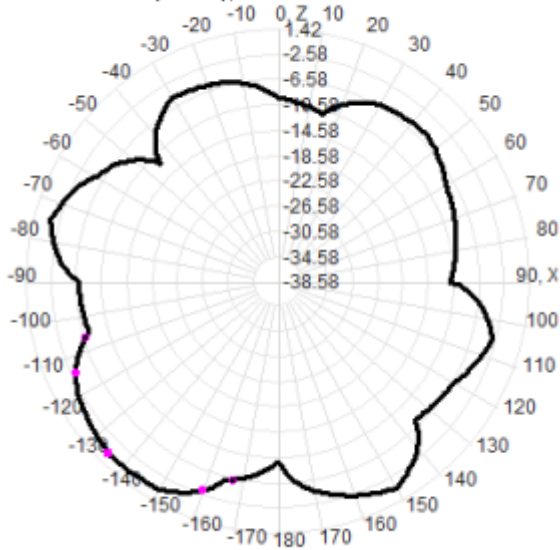

850.0MHz Total(E2-YZ), Max= 1.42dBi

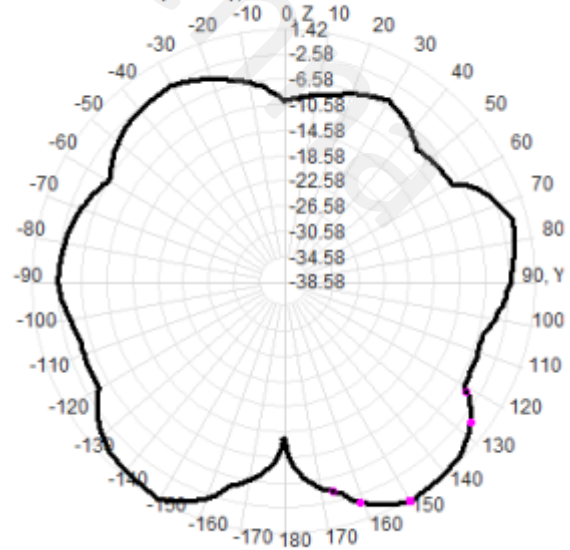

960.0MHz H+V, Eff: 42.9%

Back View

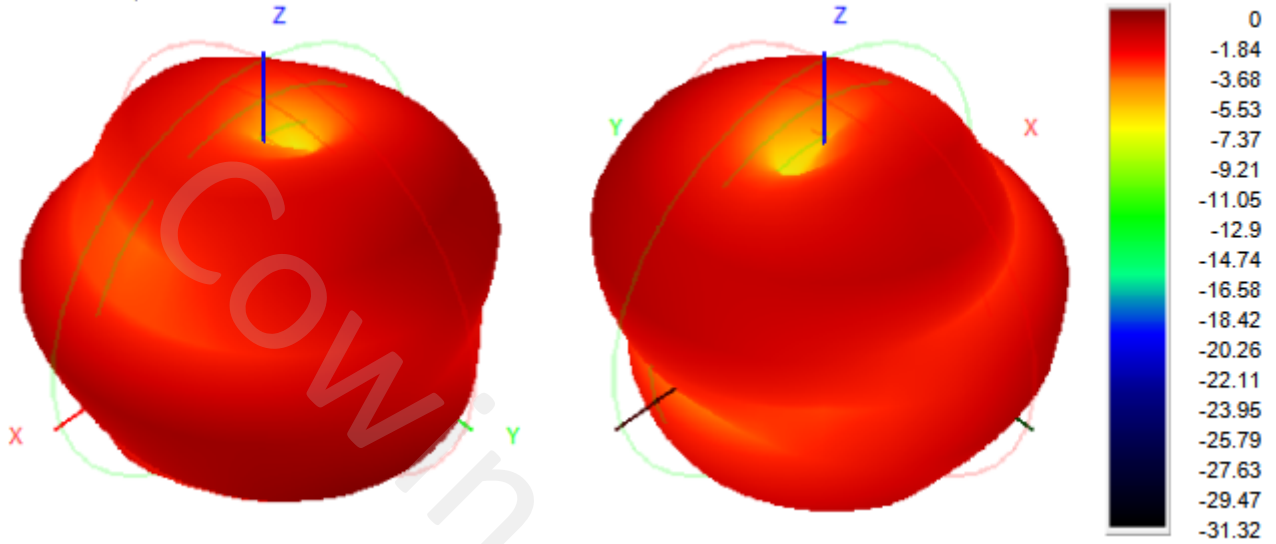

960.0MHz Total(E1-XZ), Max=-1.44dBi

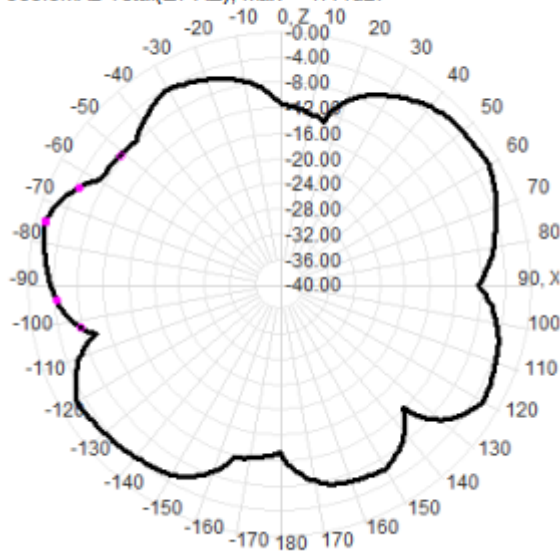

960.0MHz Total(E2-YZ), Max=-0.97dBi

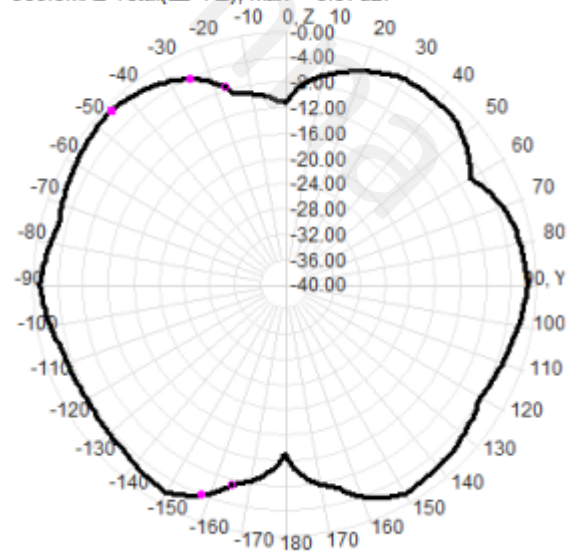

1710.0MHz H+V, Eff: 43.6%

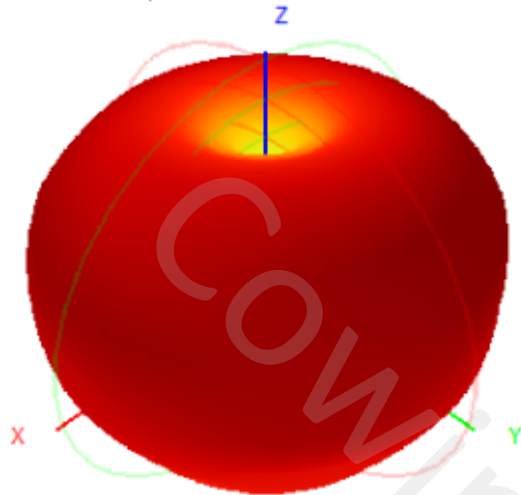

Back View

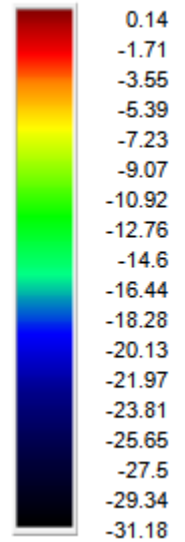
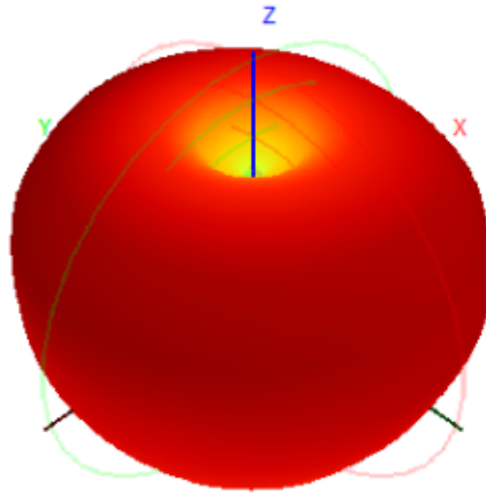

1710.0MHz Total(E1-XZ), Max=-0.31dBi

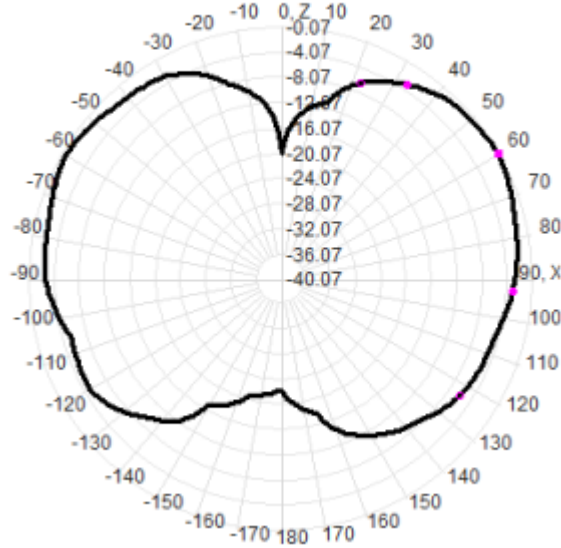

1710.0MHz Total(E2-YZ), Max=-0.07dBi

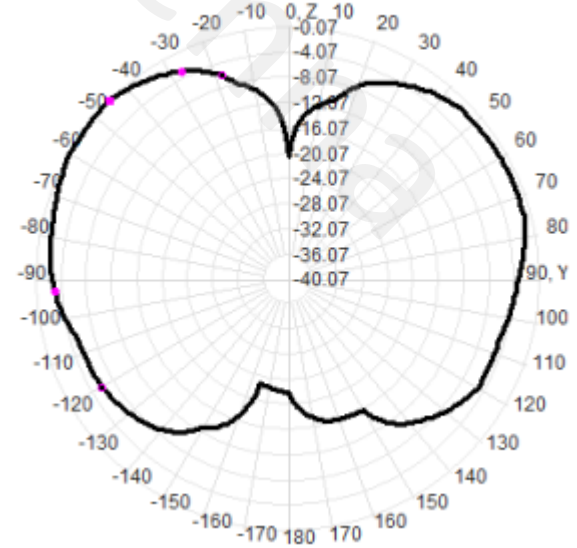

2310.0MHz H+V, Eff: 49.3%

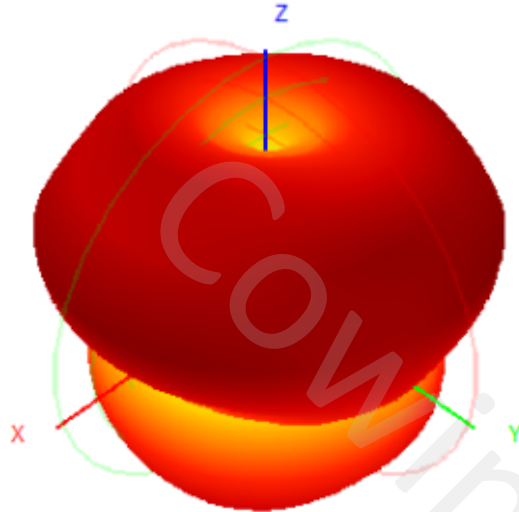

Back View

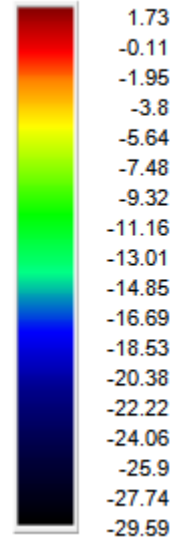
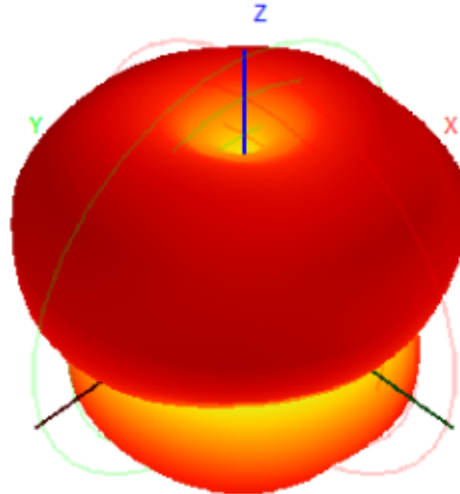

2310.0MHz Total(E1-XZ), Max= 1.34dBi

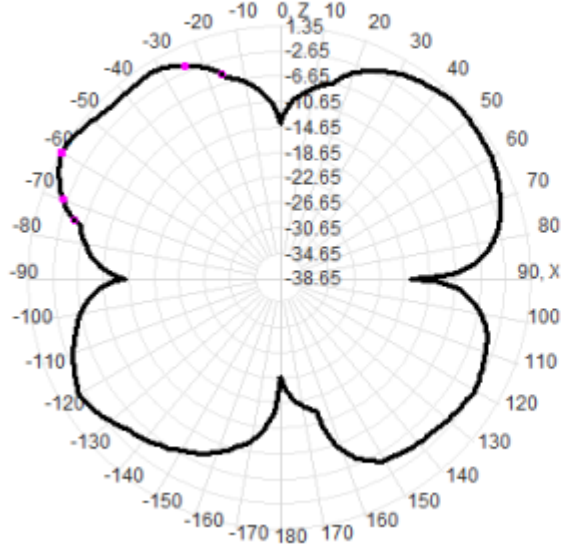

2310.0MHz Total(E2-YZ), Max= 1.35dBi

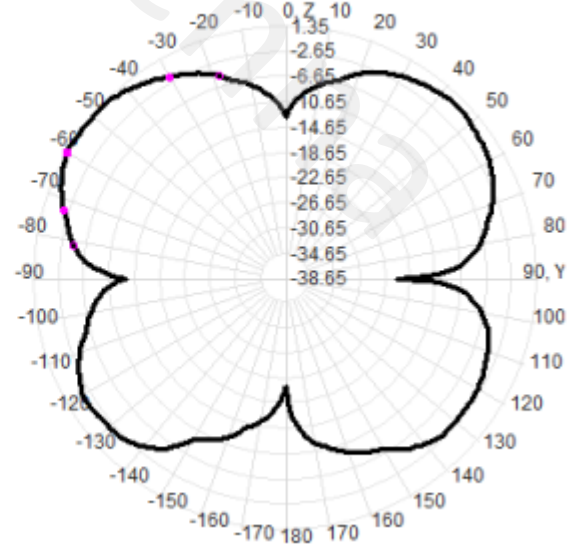

2710.0MHz H+V, Eff: 59.2%

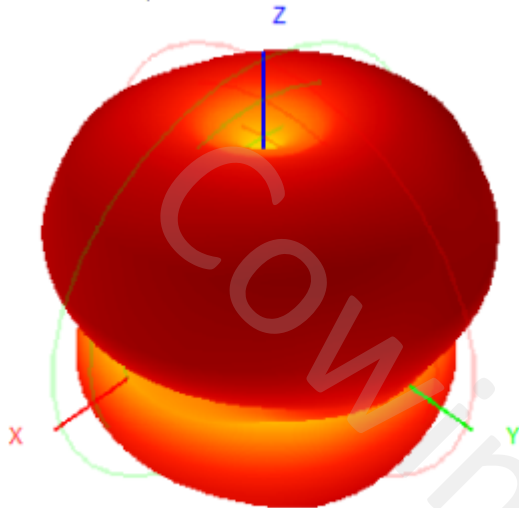

Back View

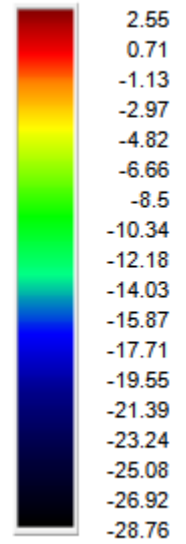
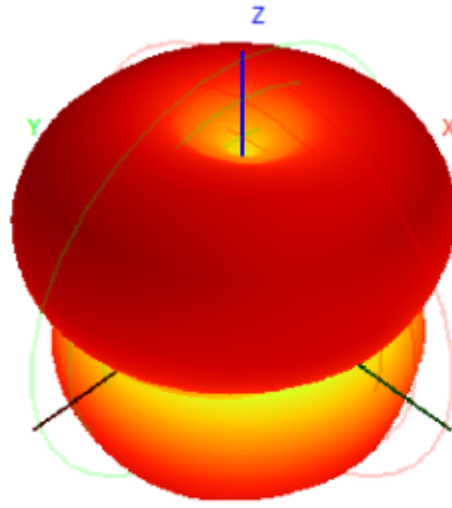

2710.0MHz Total(E1-XZ), Max= 2.14dBi

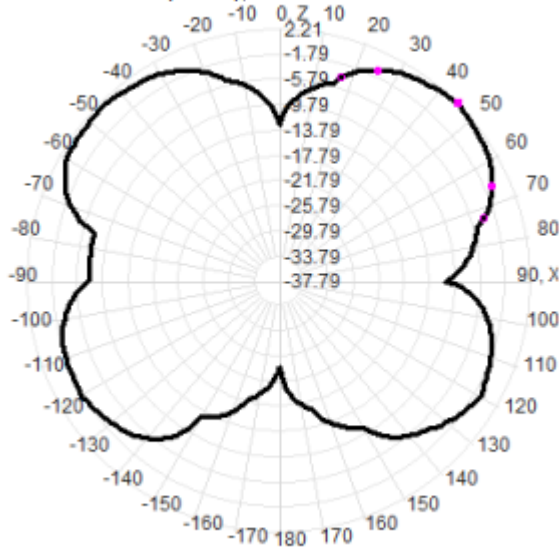

2710.0MHz Total(E2-YZ), Max= 2.21dBi

